

# NHD-4.3-480272EF-ASXV#

## TFT (Thin-Film-Transistor) Color Liquid Crystal Display Module

NHD-	Newhaven Display
4.3-	4.3" Diagonal
480272-	480xRGBx272 Pixels
EF-	Model
A-	Built-in Driver / No Controller
S-	High Brightness, White LED Backlight
X-	TFT
V-	MVA Type, Wide Temperature
#-	<b>RoHS Compliant</b>

**Newhaven Display International, Inc.**

2661 Galvin Ct.

Elgin IL, 60124

Ph: 847-844-8795

Fax: 847-844-8796

[www.newhavendisplay.com](http://www.newhavendisplay.com)

[nhtech@newhavendisplay.com](mailto:nhtech@newhavendisplay.com)

[nhsales@newhavendisplay.com](mailto:nhsales@newhavendisplay.com)

## Document Revision History

Revision	Date	Description	Changed by
0	4/29/2014	Initial Release	ML
1	6/24/2014	Timing characteristics updated	ML
2	8/11/15	Part number changed from ATXV#-3 to ASXV#	AK
3	12/21/15	Added Backlight Lifetime Rating, Datasheet Reformat	SB
4	11/28/16	Contrast Ratio & Supply Current Updated	SB
5	1/6/17	V <sub>LED</sub> Updated	SB
6	3/31/17	Driver IC Updated	SB
7	1/28/18	FPC Schematic Updated	SB

## Functions and Features

- 480xRGBx272 resolution, up to 16.7M colors
- 12-LED backlight
- 24-Bit RGB interface
- Resistive and Capacitive touch panel available

1	2	3	4	5	6	7	8
				SYMBOL	REVISION		DATE

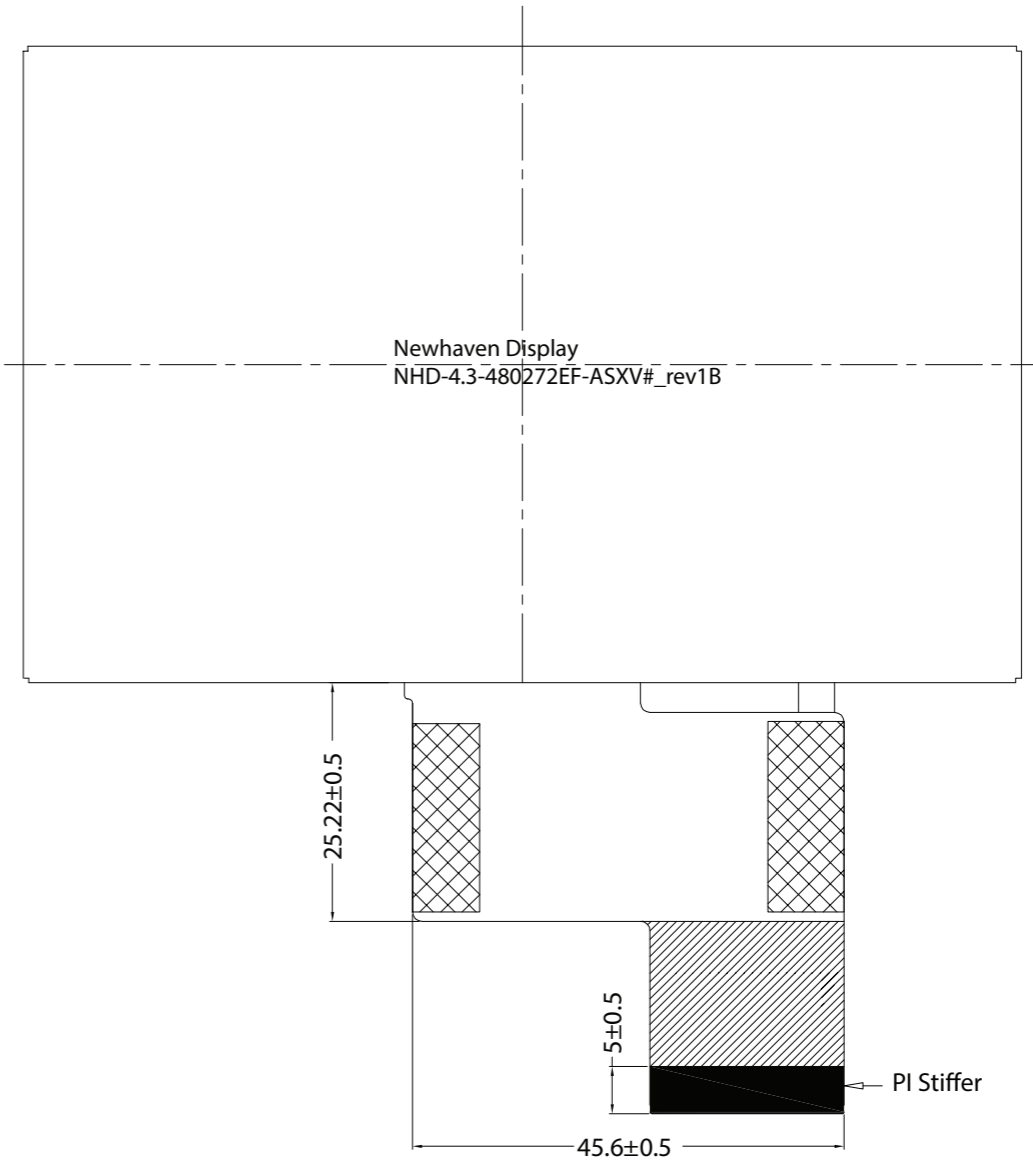
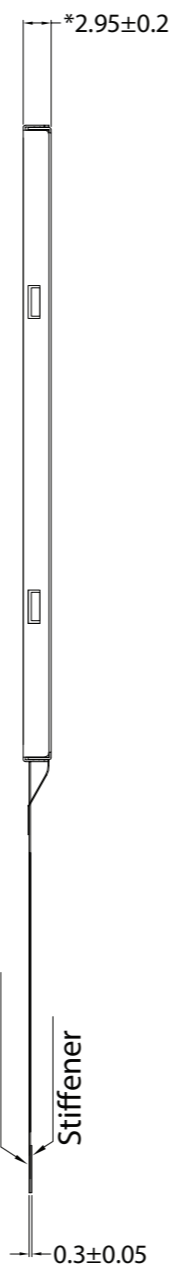
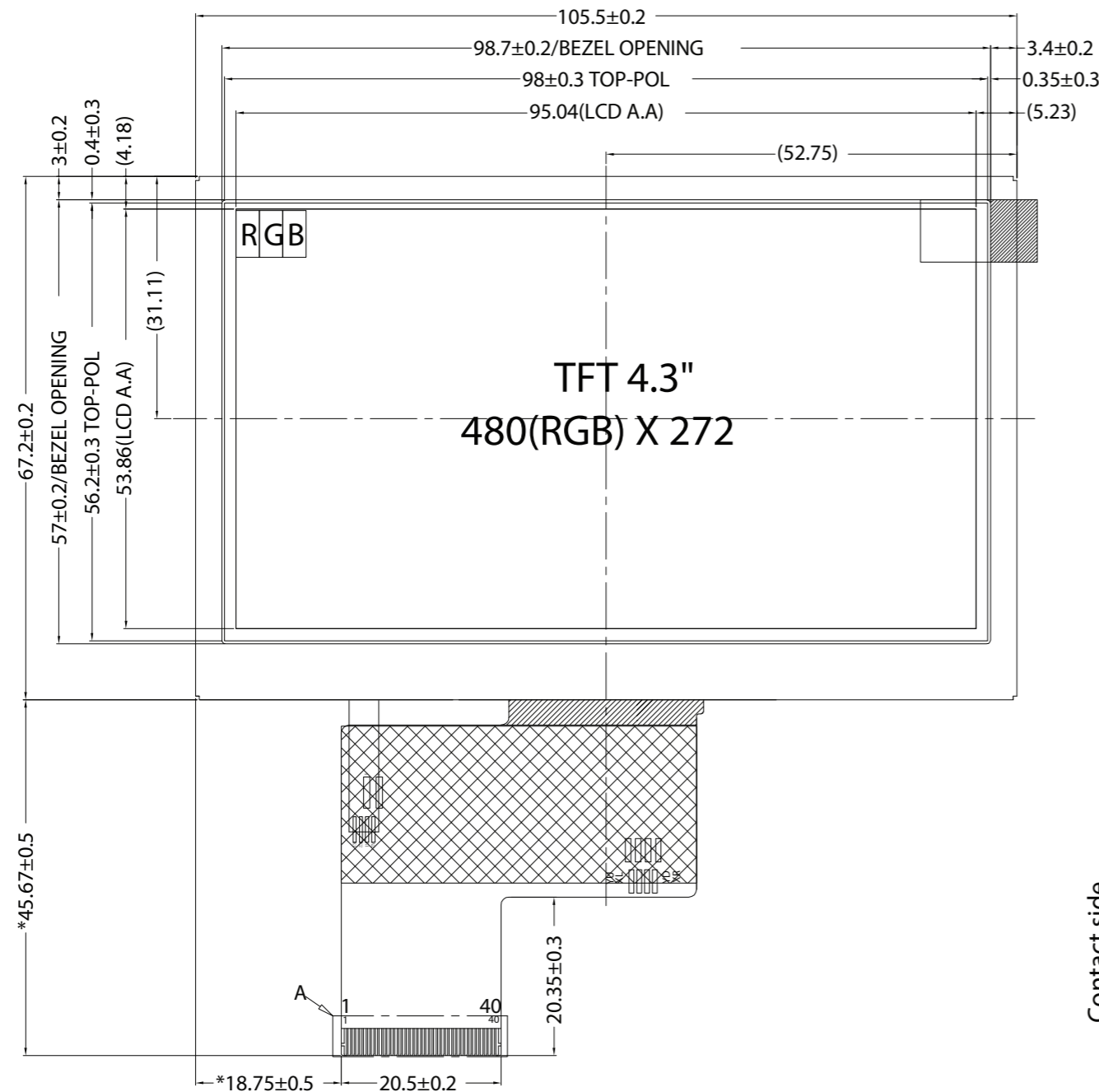

Pin Assignment	
PIN	SYMBOL
1	LEDK
2	LEDA
3	GND
4	VCC
5	R0
6	R1
7	R2
8	R3
9	R4
10	R5
11	R6
12	R7
13	G0
14	G1
15	G2
16	G3
17	G4
18	G5
19	G6
20	G7
21	B0
22	B1
23	B2
24	B3
25	B4
26	B5
27	B6
28	B7
29	GND
30	CLK
31	DISP
32	Hsync
33	Vsync
34	DEN
35	NC
36	GND
37	NC (YU)
38	NC (XL)
39	NC (YD)
40	NC (XR)

Notes:

1. Display Size: 4.3" TFT
2. Optimal View: Full View
3. Display Mode: Transmissive / Normally White / Anti-Glare
4. Driver IC: ST7282T2
5. Supply Voltage: 3.3 V
6. Backlight: White LED / 40mA / 25.6V (Typ)
7. Brightness: 850 cd/m<sup>2</sup> (Typ)

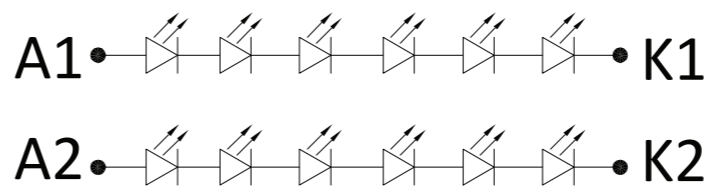
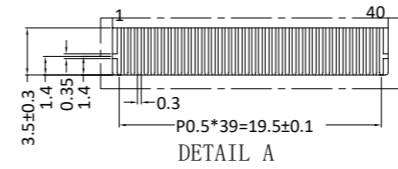

STANDARD TOLERANCE: (UNLESS OTHERWISE SPECIFIED)		
LINEAR: ±0.3mm	DRAWING/PART NUMBER: NHD-4.3-480272EF-ASXV#	
	REVISION: 1B	SIZE: A3
UNLESS OTHERWISE SPECIFIED: - DIMENSIONS ARE IN MILLIMETERS - THIRD ANGLE PROJECTION	DRAWN BY: S. Baxi	APPROVED BY: S. Baxi
	DRAWN DATE: 1/28/18	APPROVED DATE: 1/28/18
	DO NOT SCALE DRAWING	
	SHEET 1 OF 1	
THIS DRAWING IS SOLELY THE PROPERTY OF NEWHAVEN DISPLAY INTERNATIONAL, INC. THE INFORMATION IT CONTAINS IS NOT TO BE DISCLOSED, REPRODUCED OR COPIED IN WHOLE OR PART WITHOUT WRITTEN APPROVAL FROM NEWHAVEN DISPLAY.		

## Pin Description

Pin No.	Symbol	External Connection	Function Description
1	LED-	Power Supply	Backlight Cathode (Ground)
2	LED+	Power Supply	Backlight Anode (25.6V @ 40 mA)
3	GND	Power Supply	Ground
4	V <sub>DD</sub>	Power Supply	Supply Voltage for LCD and logic (3.3V)
5-12	[R0-R7]	MPU	Red Data signals
13-20	[G0-G7]	MPU	Green Data signals
21-28	[B0-B7]	MPU	Blue Data signals
29	GND	Power Supply	Ground
30	CLK	MPU	Data sample Clock signal (Falling Edge Triggered)
31	DISP	MPU	Display Control Signal (High: ON (Default), Low: Standby)
32	HSYNC	MPU	Line synchronization signal
33	VSYNC	MPU	Frame synchronization signal
34	DEN	MPU	Data Enable signal
35	NC	-	No Connect
36	GND	Power Supply	Ground
37	NC	-	No Connect
38	NC	-	No Connect
39	NC	-	No Connect
40	NC	-	No Connect

**Recommended LCD connector:** 0.5mm pitch 40-Conductor FFC. Molex p/n: 54132-4062

**Backlight connector:** on LCD connector      **Mates with:** ---

## Electrical Characteristics

Item	Symbol	Condition	Min.	Typ.	Max.	Unit
Operating Temperature Range	T <sub>OP</sub>	Absolute Max	-20	-	+70	°C
Storage Temperature Range	T <sub>ST</sub>	Absolute Max	-30	-	+80	°C
Supply Voltage	V <sub>DD</sub>	-	3.0	3.3	3.6	V
Supply Current	I <sub>DD</sub>	V <sub>DD</sub> = 3.3V	12	25	50	mA
"H" level input	V <sub>IH</sub>	-	0.7 * V <sub>DD</sub>	-	V <sub>DD</sub>	V
"L" level input	V <sub>IL</sub>	-	V <sub>SS</sub>	-	0.3 * V <sub>DD</sub>	V
Backlight Supply Current	I <sub>LED</sub>	-	-	40	50	mA
Backlight Supply Voltage	I <sub>LED</sub>	I <sub>LED</sub> = 40mA	22.4	25.6	27.2	V
Backlight Lifetime*	-	I <sub>LED</sub> = 40mA T <sub>OP</sub> = 25°C	20,000	50,000	-	Hrs.

\*Backlight is current driven; do not supply more than 50 mA. Backlight lifetime is rated as Hours until **half-brightness**, under normal operating conditions.

## Optical Characteristics

Item	Symbol	Condition	Min.	Typ.	Max.	Unit	
Optimal Viewing Angles	Top	CR ≥ 10	-	75	-	°	
	Bottom		-	75	-	°	
	Left		-	75	-	°	
	Right		-	75	-	°	
Contrast Ratio	CR	-	400	500	-	-	
Luminance	L <sub>V</sub>	I <sub>LED</sub> = 40 mA	680	850	-	cd/m <sup>2</sup>	
Response Time	Rise + Fall	T <sub>R</sub> +T <sub>F</sub>	T <sub>OP</sub> = 25°C	-	20	30	ms
Chromaticity	Red	X <sub>R</sub>	-	0.531	0.581	0.631	-
		Y <sub>R</sub>	-	0.300	0.350	0.400	-
	Green	X <sub>G</sub>	-	0.263	0.313	0.363	-
		Y <sub>G</sub>	-	0.568	0.618	0.668	-
	Blue	X <sub>B</sub>	-	0.093	0.143	0.193	-
		Y <sub>B</sub>	-	0.050	0.100	0.150	-
White	X <sub>W</sub>	-	0.233	0.283	0.333	-	
	Y <sub>W</sub>	-	0.286	0.336	0.386	-	

\* Luminance is directly related to Backlight Supply Current.

## Driver Information

Built-in Sitronix ST7282T2 Driver.

Please download specification at <http://www.newhavendisplay.com/appnotes/datasheets/LCDs/ST7282T2.pdf>

# Timing Characteristics

## Parallel RGB input timing requirement

Item		Symbol	Min.	Typ.	Max.	Unit	Remark
DCLK Frequency		FCLK	9	12	15	MHz	
DCLK Period		TCLK	10	50	-	μS	R=10KΩ, 1μF
HSYNC	Period Time	Th	485	525	532	DCLK	
	Display Period	Thdisp	-	480	-	DCLK	
	Back Porch	Thbp	3	43	50	DCLK	By H_Blanking Setting
	Front Porch	Thfp	2	2	2	DCLK	
	Pulse Width	Thw	1	1	1	DCLK	
VSYNC	Period Time	Tv	275	285	303	H	
	Display Period	Tvdisp	-	272	-	H	
	Back Porch	Tvbp	2	12	30	H	By V_Blanking Setting
	Front Porch	Tvfp	1	1	1	H	
	Pulse Width	Tvw	1	1	1	H	

- SYNC Mode Timing

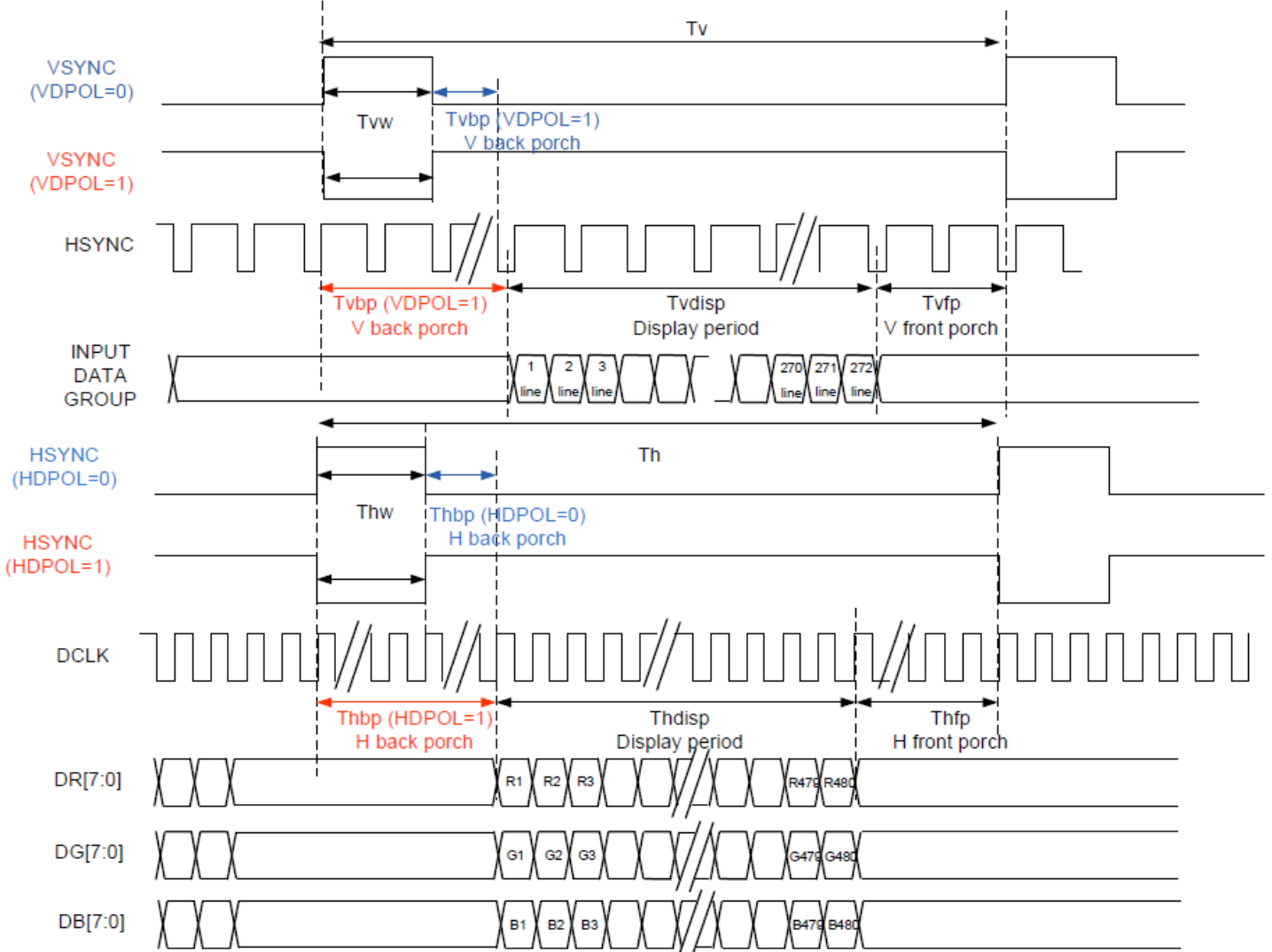

- SYNC-DE Mode Timing

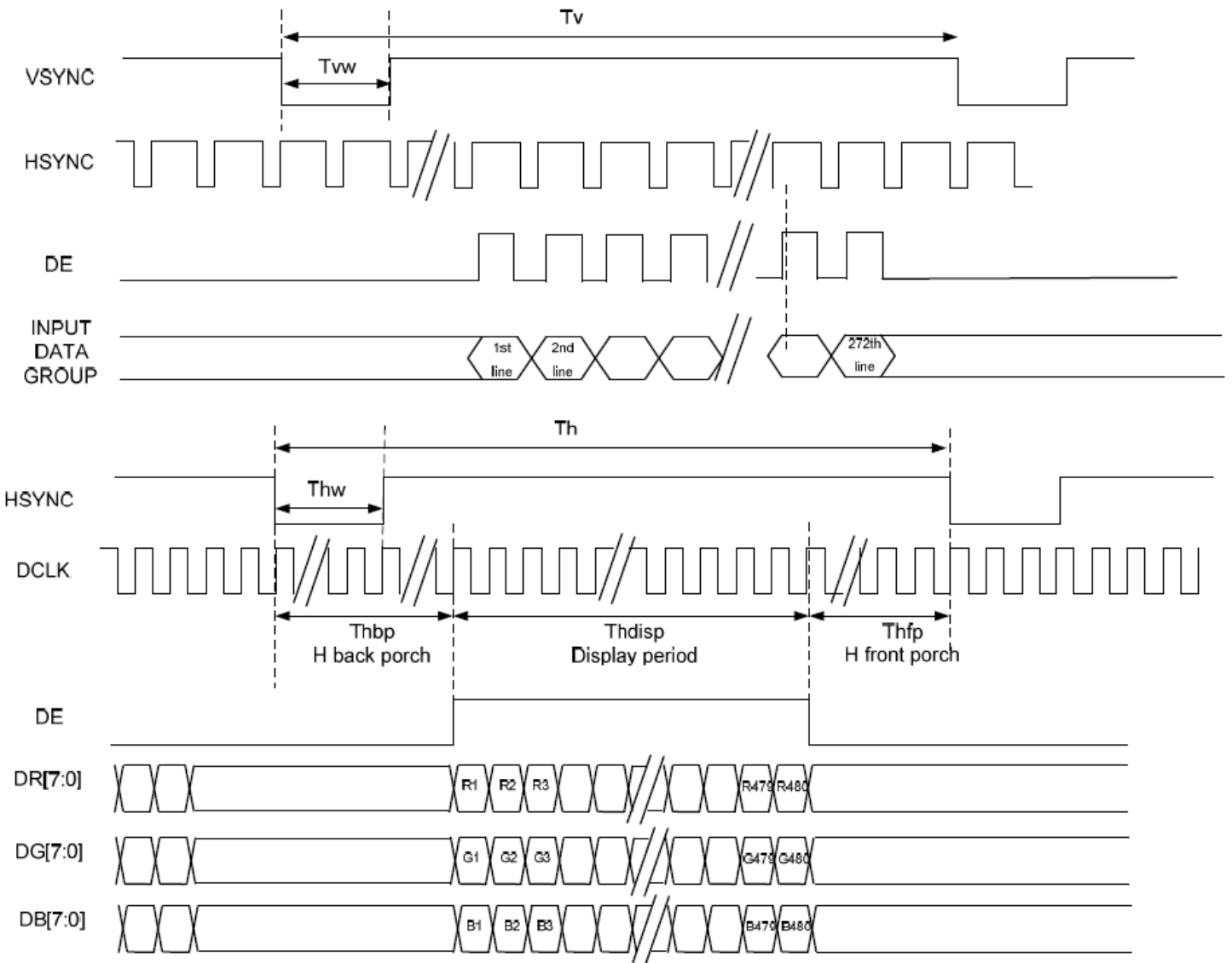



## Input setup timing requirement

Item	Symbol	Min.	Typ.	Max.	Unit	Conditions
System Operation Timing						
V <sub>DD</sub> Power Source Slew Time	TPOR	-	-	20	ms	From 0V to 99% V <sub>DD</sub>
GRB Pulse Width	tRSTW	10	50	-	μS	R=10KΩ, 1μF
Input / Output Timing						
CLK pulse Duty	TCW	40	50	60	%	
Hsync Width	Thw	1	-	-	DCLK	
Hsync Period	Th	50	60	65	μS	
Vsync setup time	Tvst	12	-	-	ns	
Vsync hold time	Tvhd	12	-	-	ns	
Hsync setup time	Thst	12	-	-	ns	
Hsync hold time	Thhd	12	-	-	ns	
Data setup time	Tdsu	12	-	-	ns	
Data hold time	Tdhd	12	-	-	ns	
SD output stable time	Tst	-	-	12	μS	Output settled within +20mV Loading = 6.8k+28.2pF
GD output rise and fall time	Tgst	-	-	6	μS	Output settled (5%~95%) Loading = 4.7k+29.8pF

### - Clock And Data Input Timing Diagram

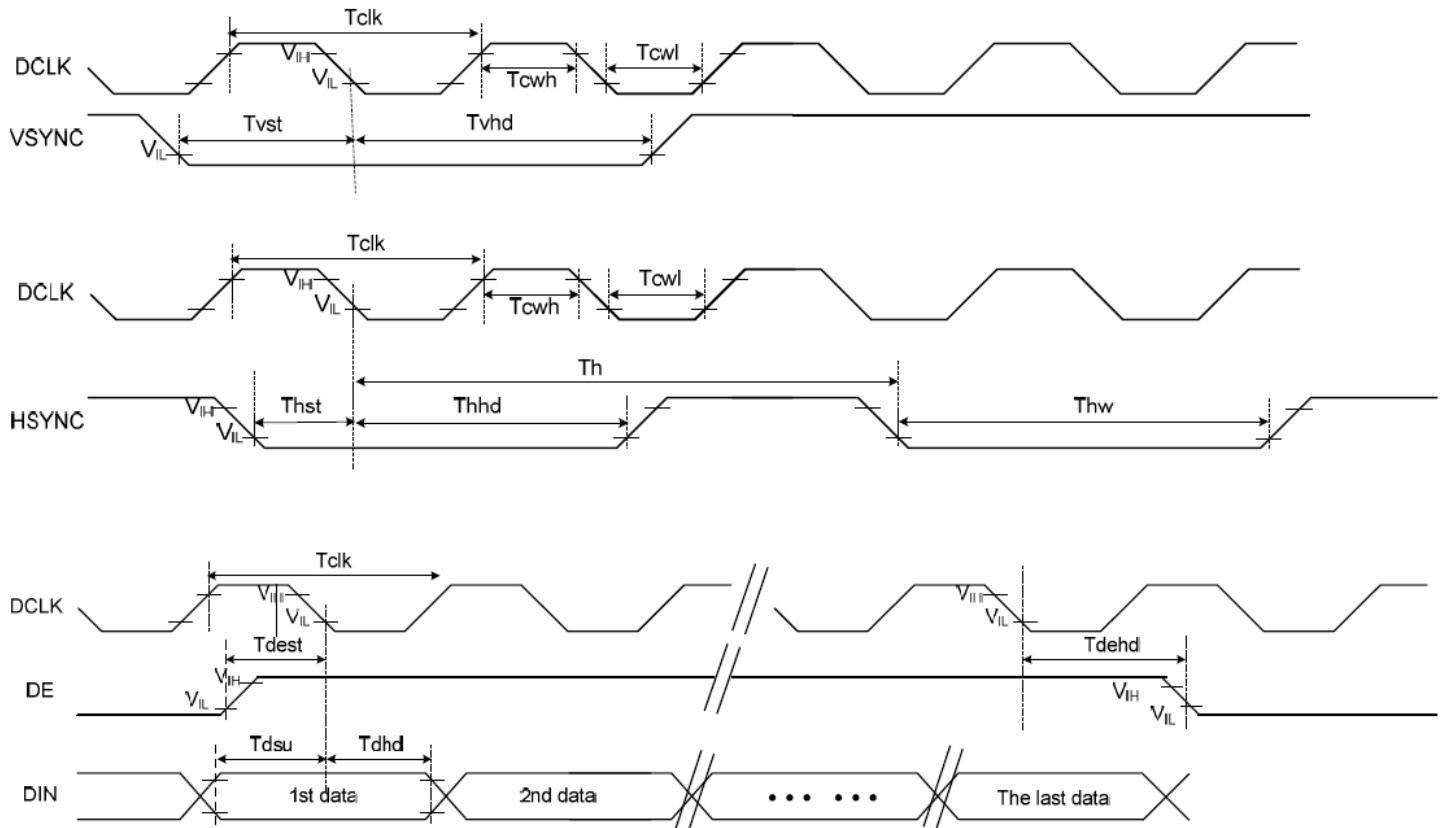

# Power On/Off Sequence

## - Power On Sequence

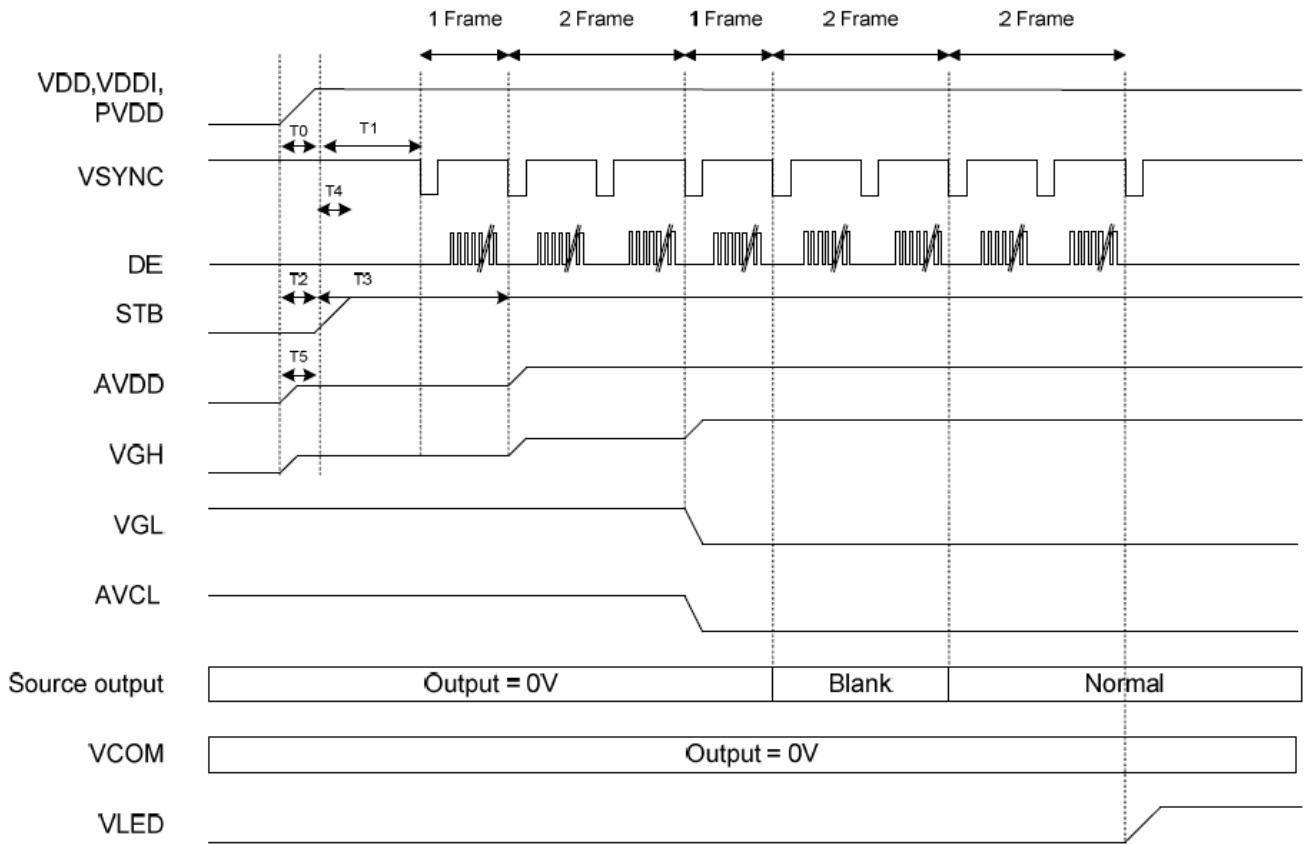

	Description	Min. Time
T0	Determined by the external power	
T1	Time from stable VDD, VDDI, PVDD set-up to the first VSYNC	T1=0
T2	Time from AVDD=0V to AVDD=3.3V	T2=T0
T3	Time from AVDD=3.3V to AVDD=6.0V	T3=T1+ (1*Frame)
T4	Time from stable VDD, VDDI, PVDD set-up to DISP asserted	T4=0
T5	Time from VGH=0V to VGH=3.3V	T5=T0

- **Power Off Sequence**

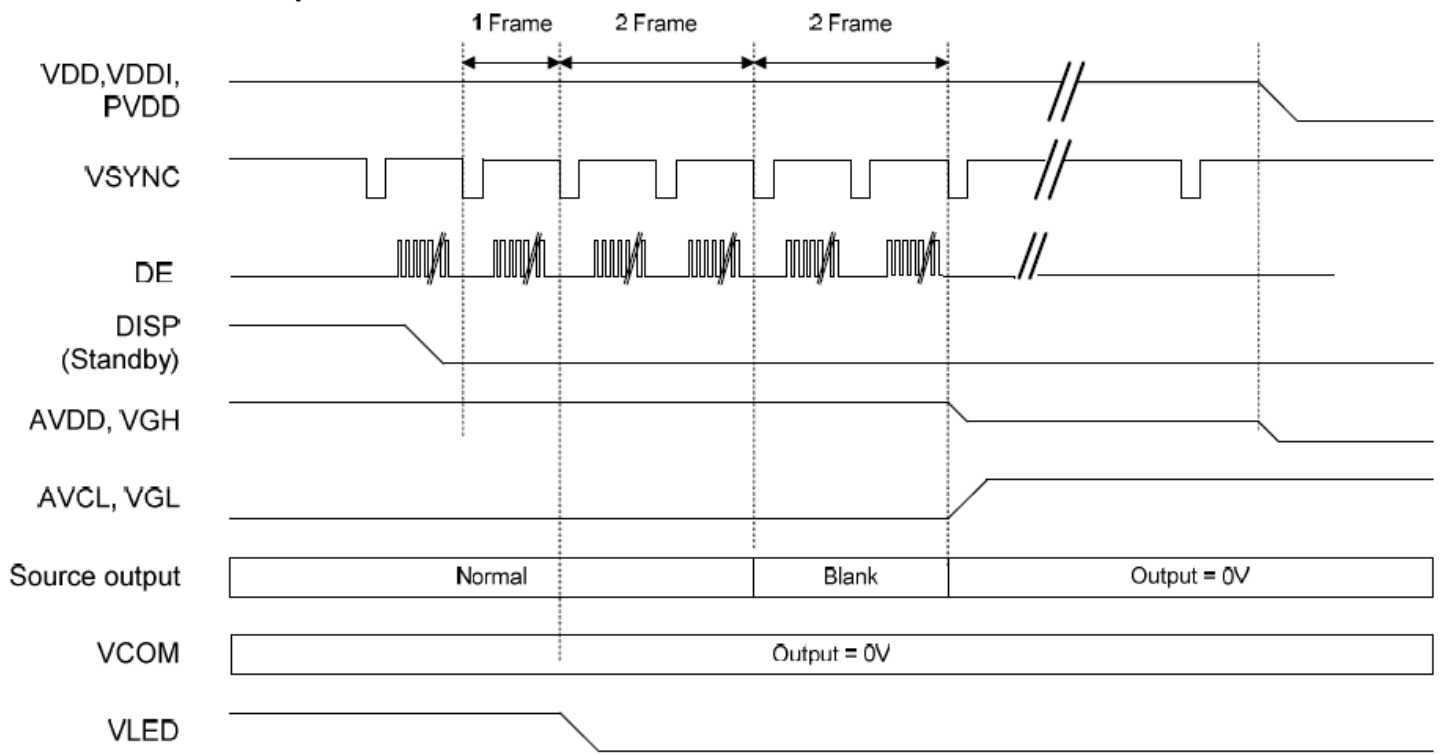

## Quality Information

Test Item	Content of Test	Test Condition	Note
High Temperature storage	Endurance test applying the high storage temperature for a long time.	+80°C , 96 Hrs.	2
Low Temperature storage	Endurance test applying the low storage temperature for a long time.	-30°C , 96 Hrs.	1,2
High Temperature Operation	Endurance test applying the electric stress (voltage & current) and the high thermal stress for a long time.	+70°C , 96 Hrs.	2
Low Temperature Operation	Endurance test applying the electric stress (voltage & current) and the low thermal stress for a long time.	-20°C , 96 Hrs.	1,2
High Temperature / Humidity Operation	Endurance test applying the electric stress (voltage & current) and the high thermal with high humidity stress for a long time.	+50°C , 90% RH , 96 Hrs.	1,2
Thermal Shock resistance	Endurance test applying the electric stress (voltage & current) during a cycle of low and high thermal stress.	-20°C,60min -> 25°C,5min ->70°C,60min = 1 cycle 20 cycles	-
Vibration test	Endurance test applying vibration to simulate transportation and use.	10-50Hz , 15mm amplitude. 30 Min. Each Direction X,Y,Z	3
Static electricity test	Endurance test applying electric static discharge.	Air: V <sub>S</sub> =±8KV, Contact: V <sub>S</sub> =±4KV R <sub>S</sub> =330Ω C <sub>S</sub> =150pF 5 Times	-

**Note 1:** No condensation to be observed.

**Note 2:** Conducted after 4 hours of storage at 25°C, 0%RH.

**Note 3:** Test performed on product itself, not inside a container.

## Precautions for using LCDs/LCMs

See Precautions at [www.newhavendisplay.com/specs/precautions.pdf](http://www.newhavendisplay.com/specs/precautions.pdf)

## Warranty Information

See Terms & Conditions at [http://www.newhavendisplay.com/index.php?main\\_page=terms](http://www.newhavendisplay.com/index.php?main_page=terms)